

# CORNER

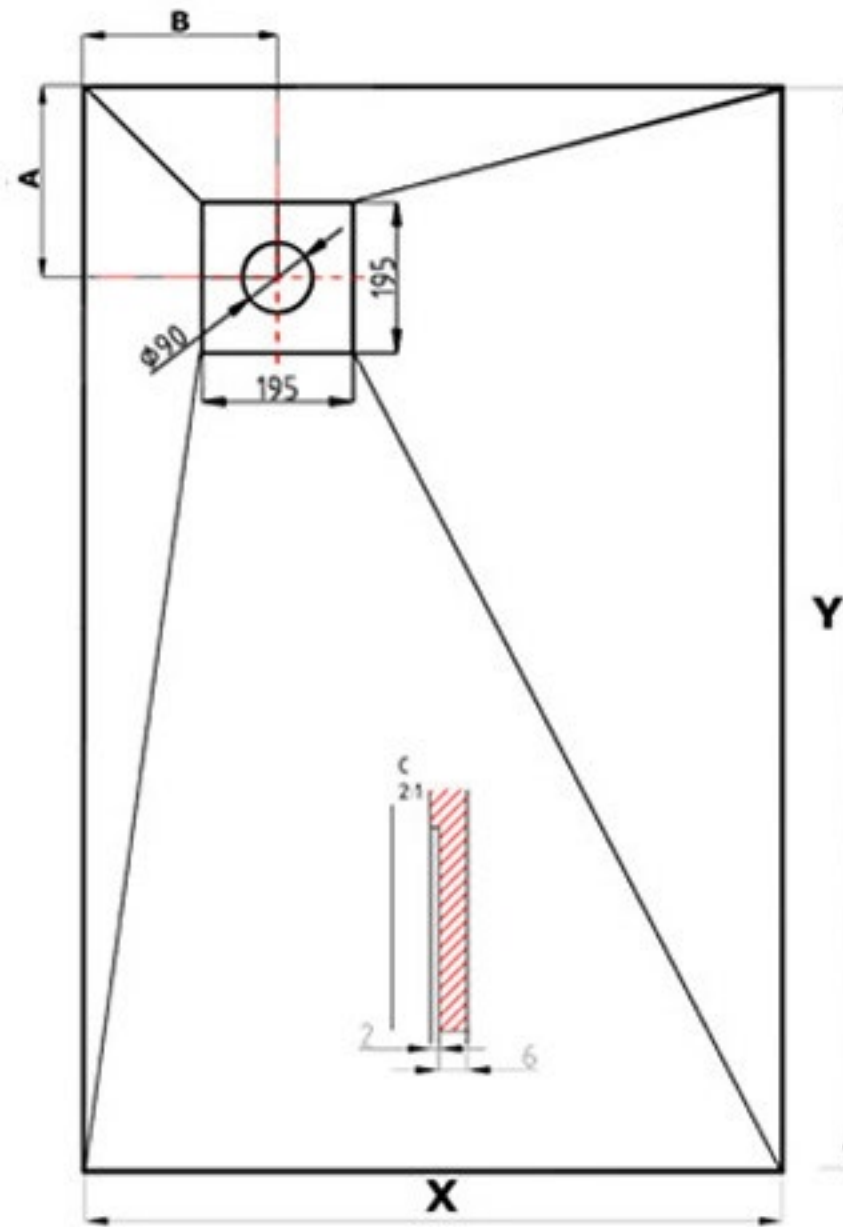

**X: 900 [mm]**  
**Y: 1600 [mm]**  
**A: 225 [mm]**  
**B: 225 [mm]**

# OFFSET

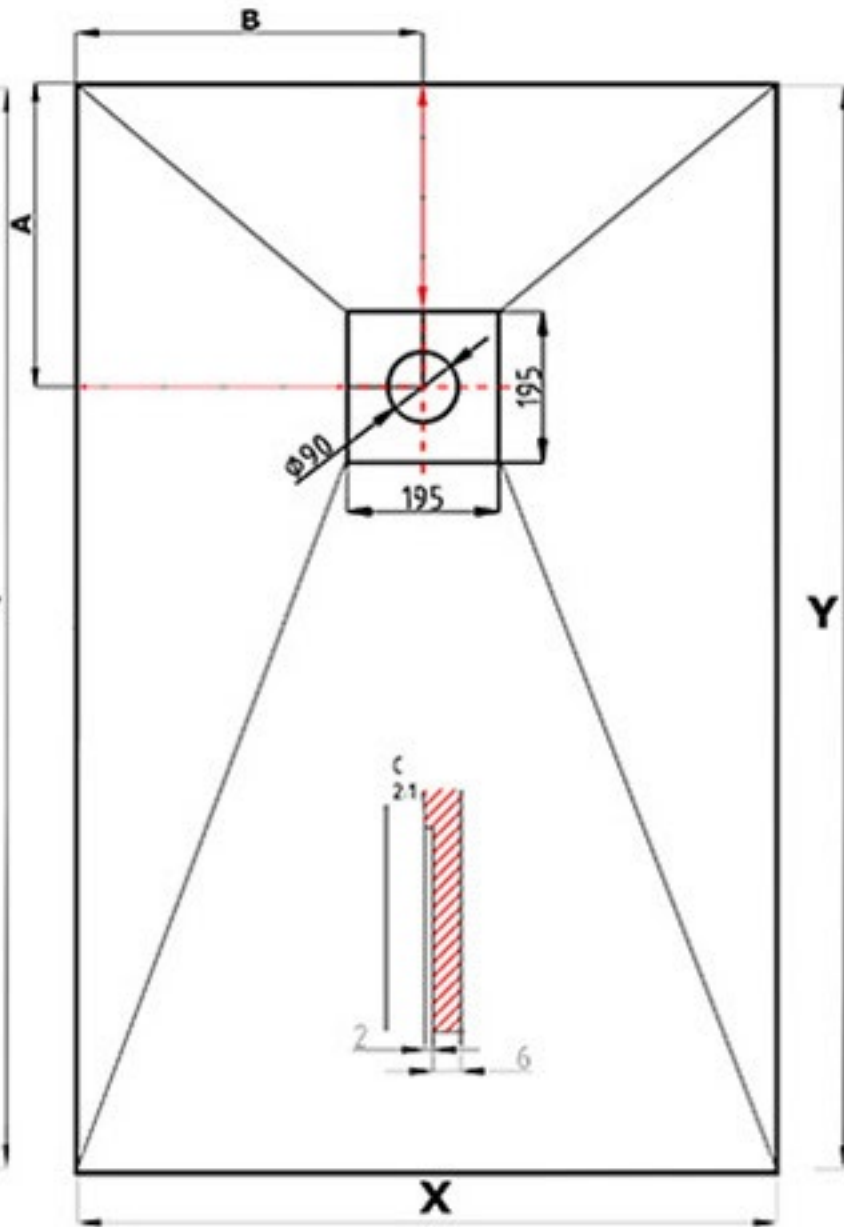

**X: 900 [mm]**  
**Y: 1600 [mm]**  
**A: 225 [mm]**  
**B: 450 [mm]**

# CENTRAL

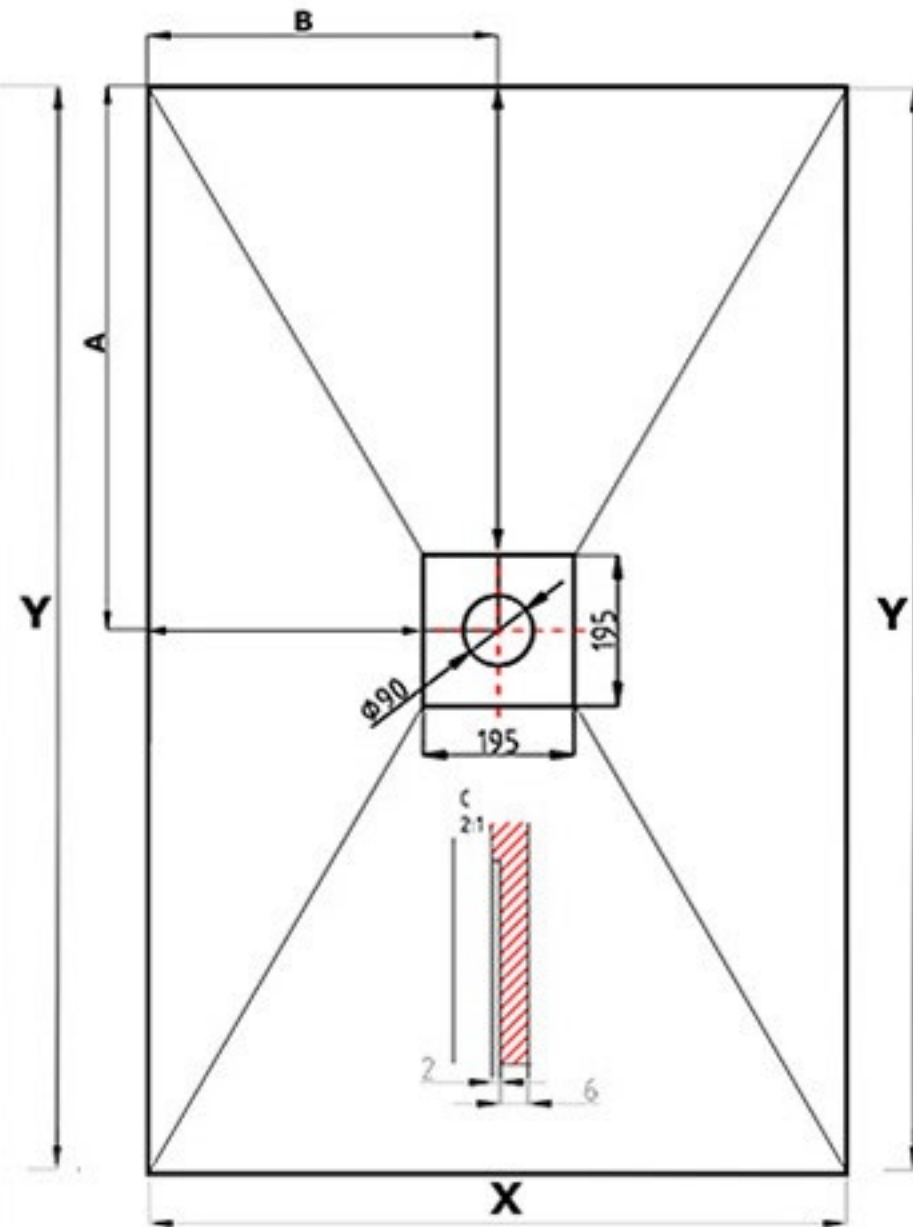

**X: 900 [mm]**  
**Y: 1600 [mm]**  
**A: 800 [mm]**  
**B: 450 [mm]**

