

# CORNER

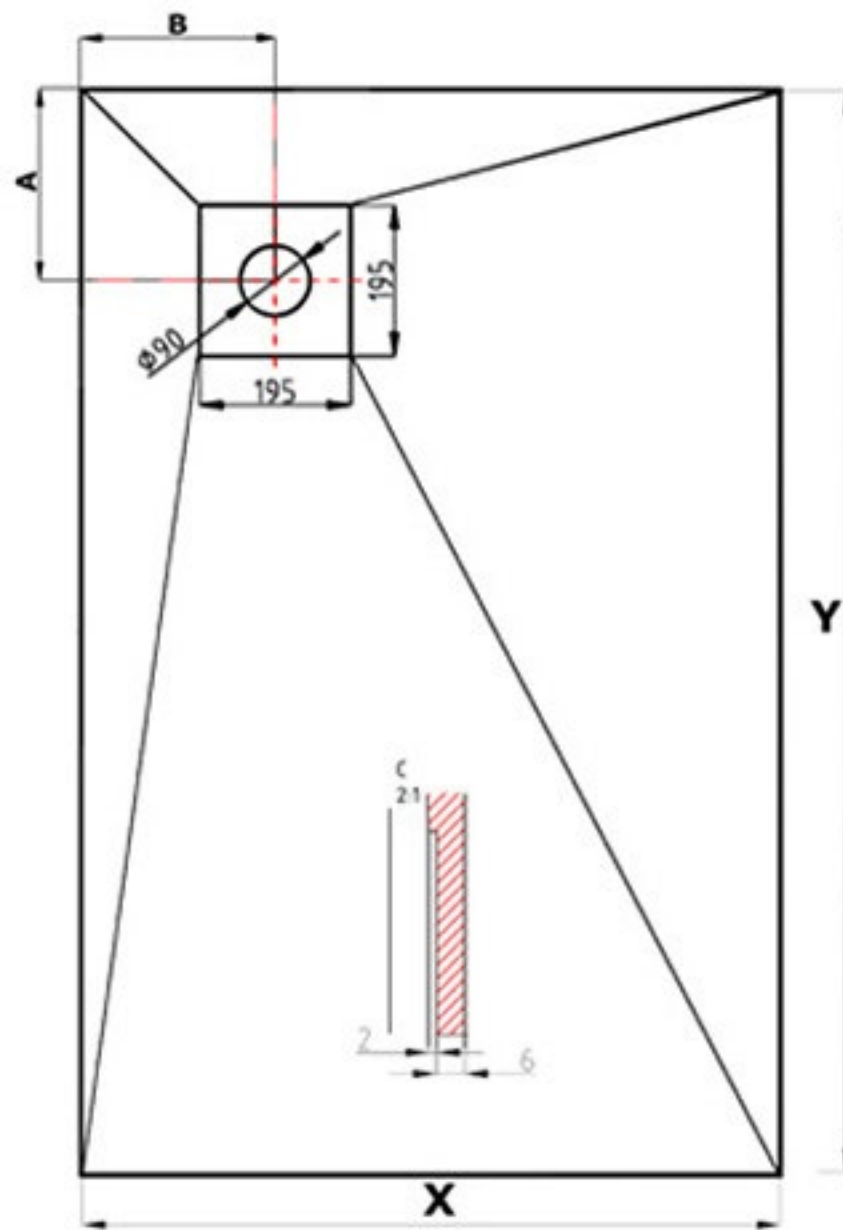

**X:** 900 [mm]  
**Y:** 1200 [mm]  
**A:** 225 [mm]  
**B:** 225 [mm]

# OFFSET

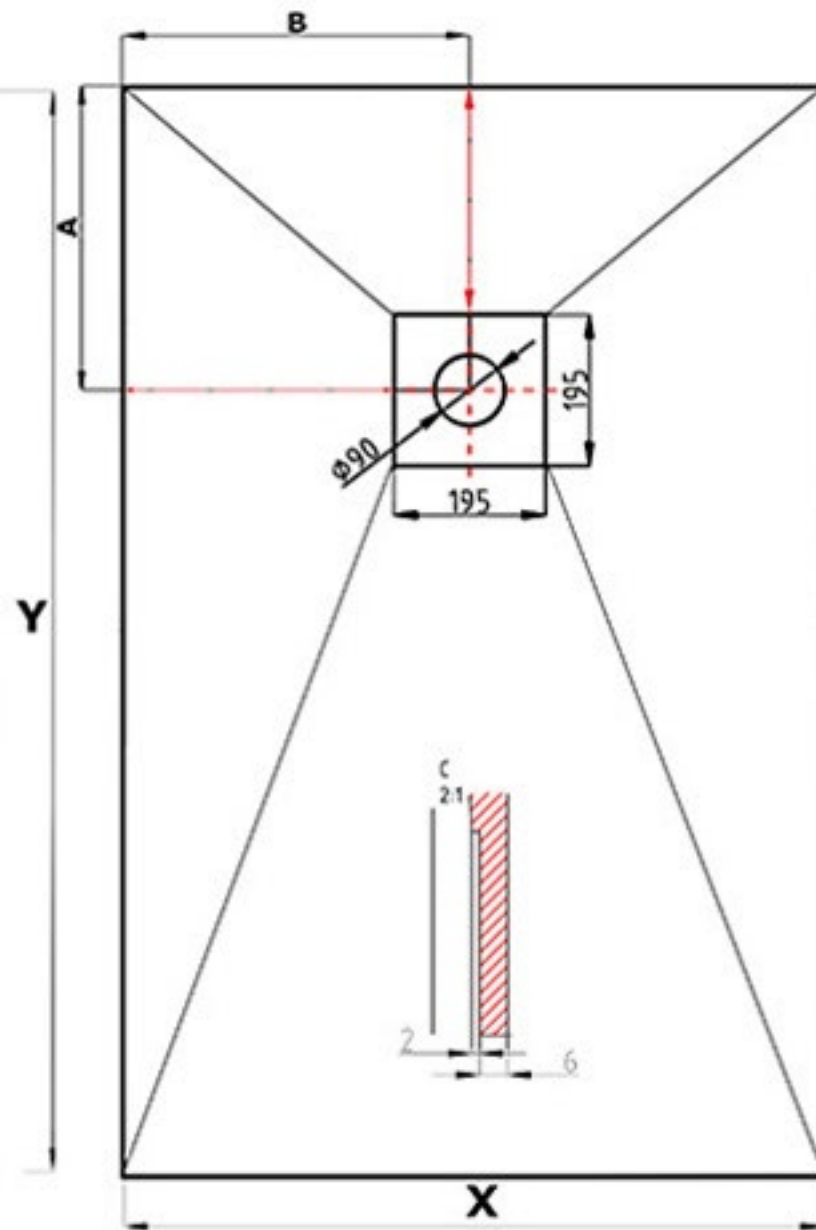

**X:** 900 [mm]  
**Y:** 1200 [mm]  
**A:** 225 [mm]  
**B:** 400 [mm]

# CENTRAL

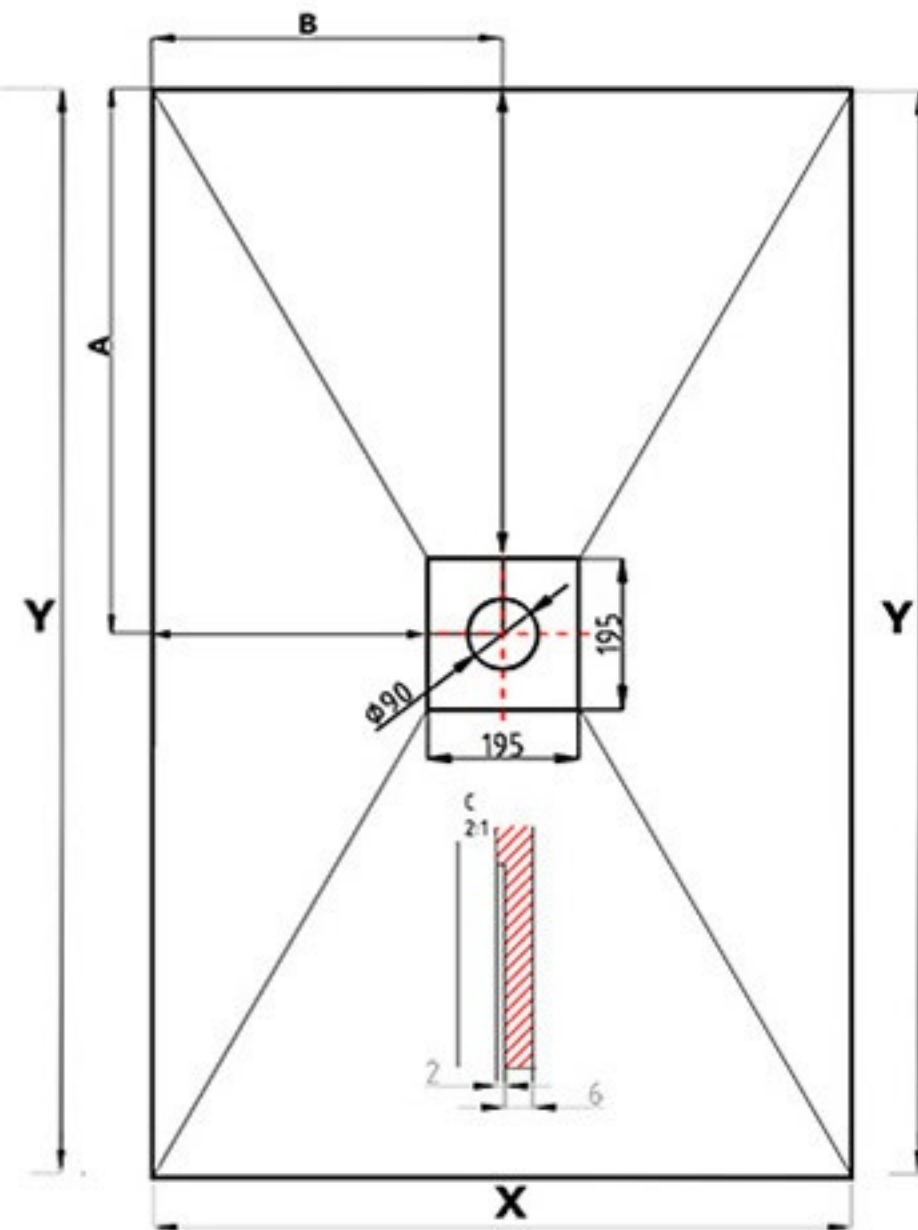

**X:** 900 [mm]  
**Y:** 1200 [mm]  
**A:** 600 [mm]  
**B:** 450 [mm]

